



KOLVER

PRECISION SCREW TIGHTENING



KOLVER
THE EASY SOLUTION
SCREWDRIVERS
2015-2016

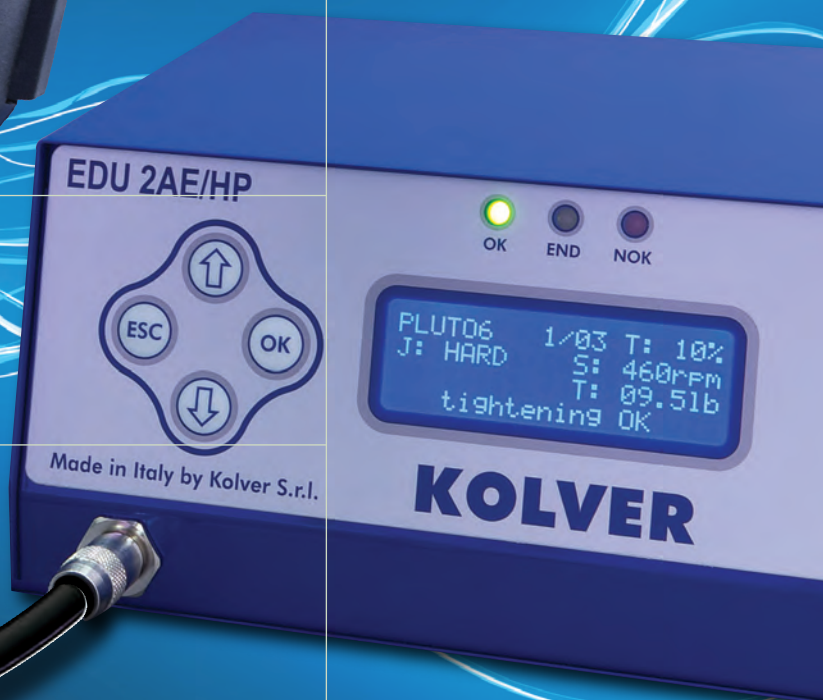

ELECTRONICS • AUTOMOTIVE • MEDICAL DEVICES
WHITE GOODS INDUSTRY • GENERAL INDUSTRY

N A T O S E R I E S



NATO Screwdrivers – Current Control with Torque Only, or Torque and Angle Capability

TORQUE UP TO 15 Ncm

Kolver's experience with current control technology has led to the creation of the NATO screwdrivers; the first ultra-low torque, truly accurate current controlled torque driver designed for applications in which torques below 0,15 Nm are required, especially in the mobile industry. The NATO features an innovative electric motor coupled with planetary gearboxes, producing extremely low inertia and minimal friction for long life, and very accurate torque production. NATO Series is available with torque only or torque and angle capabilities.

Model NATO 15D ranges in torque from 1–15 Ncm, and features an ESD-safe housing and cord set or aluminium body (20mm diameter), for fixture mount applications. Drivers are inline style, with a lever start actuation. NATO systems are available with our 8 P-set programmable controllers for maximum versatility. Foot pedals are available in cases where the operator would like the convenience of manual operation with the NATO/CA series.

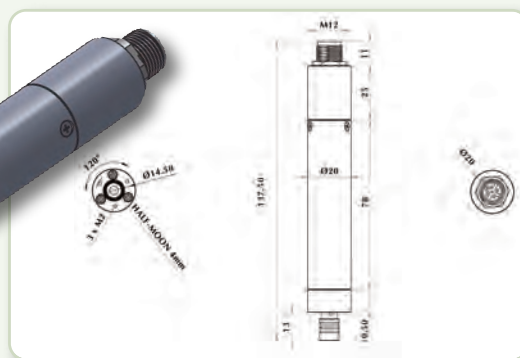

EDU2AE/TOP/NT

Features of the NATO and EDU2AE/TOP/NT System:

- An ultra low torque range of 1–15 Ncm.
- RPM: ranges from 350–700 rpm.
- DC current controlled low inertia, low voltage ironless motor.
- The NATO inline driver is also offered as the NATO15CA fixture mount model for automation and robotic use.
- 4mm half moon chuck.
- Up to eight (8) P-sets available.
- 1–99 Screws per program.
- Adjustable torque.
- Soft joint configuration only.
- Adjustable Brake (slow speed) time.
- Adjustable Ramp (slow start) time.
- Adjustable Minimum and Maximum rundown time setting.
- Auto reverse setting with adjustable speed and adjustable torque.
- Prevailing Torque (thread cutting) capability.
- Programmable left or right rotation.
- Unscrew lockout capability.
- Programmable controller calibration.
- Nm, lbf.in or kgf.cm setting.
- Adjustable Minimum and Maximum torque setting.
- Barcode programming capability.
- Programmable sequencing.
- Six language settings.
- Password protected.

NATO System with Torque only

Model	Code	Torque	RPM range	Weight Kg	Dimensions mm	Style
NATO15D	160015	1-15 Ncm	350–700	0.45	200x32,5	Inline
NATO15CA (Aluminium body, remote start)	163015	1-15 Ncm	350–700	0.50	130x20	Inline
EDU2AE/TOP/NT Controller	031000/TOP/NT	Programmable torque (8 P-sets) with user interface screens		2.50	200x170x110	

NATO System with Torque and Angle

NATO15D/TA	160015/TA	1-15 Ncm	350–700	0.45	200x32,5	Inline
NATO15CA/TA (Aluminium body, remote start)	163015/TA	1-15 Ncm	350–700	0.50	130x20	Inline
EDU2AE/TOP/NT/TA Controller	031000/TOP/NT/TA	Programmable torque & angle (8 P-sets) with user interface screens		2.50	200x170x110	

MITO Screwdrivers – Current Control with Torque Only, or Torque and Angle Capability

TORQUE RANGE FROM 0,2–1,5 Nm

Kolver's experience with current control technology has led to the creation of the MITO series; a truly unique low torque and accurate current controlled torque driver. The MITO features an innovative electric motor coupled with planetary gearboxes, producing extremely low inertia and minimal friction for long life, and very accurate torque production. MITO Series is available in torque, or torque and angle models.

Model MITO 15D ranges in torque from 0,2–1,5 Nm, and features an ESD-safe housing and cord set, compact ergonomic design. Drivers are available in pistol or inline style, catering to operator preference and comfort. MITO systems are available with our 8 P-set programmable controllers for maximum versatility. MITO systems work in conjunction with all EDU2AE series controllers for maximum versatility.



EDU2AE/TOP/TA

Features of the EDU2AE/TOP:

- Up to eight (8) P-sets available.
- Programmable sequencing.
- 1–99 Screws per program.
- Adjustable torque.
- Hard or Soft joint configuration.
- Adjustable Brake (slow speed) time.
- Adjustable Ramp (slow start) time.
- Adjustable speed control (450–850 RPM).
- Adjustable Minimum and Maximum rundown time setting.
- Auto reverse setting with adjustable speed and adjustable torque.
- Prevailing Torque (thread cutting) capability.
- Programmable left or right rotation.
- Unscrew lockout capability.
- Programmable controller calibration.
- Nm, lbf.in or kgf.cm setting.
- Adjustable Minimum and Maximum torque setting.
- Barcode, switchbox and socket tray programming capability.
- Multilanguage software.
- Password protected.

Features of the EDU2AE/TOP/TA:

- All of the above features.
- 6 torque and angle strategies:
 - Torque priority: angle count from torque threshold (T) or from remote input (T/I) or from lever input (T/L).
 - Angle priority: driver stops when angle is reached from threshold torque (A) or from remote input (A/I) or from lever (A/L).

MITO Drivers

Model	Code	Torque Nm	RPM range	Weight Kg	Dimensions mm	Torque Adjustment	Style
MITO15D	170015	0.2-1.5	450–850	0.50	226x36	Current	Inline
MITO15D/TA (Torque and Angle)	170015/TA	0.2-1.5	450–850	0.50	226x36	Current	Inline

MITO Controllers

Model	Code	Features	Weight Kg	Dimensions mm	Screwdriver
EDU2AE/TOP	031000/TOP	Programmable Torque (8 P-sets) with user interface screens	4.0	190x205x120	MITO15D
EDU2AE/TOP/TA	031000/TOP/TA	Programmable Torque & Angle (8 P-sets) with user interface	4.0	190x205x120	MITO15D/TA

EDU2AE/TOP/MITO and EDU2AE/TOP/MITO/TA for torque range 0.1-1.5 Nm and 100–850 RPM available upon request

PLUTO SERIES

PLUTO Screwdrivers – Current Control & Clutch Style

TORQUE UP TO 50 Nm

Kolver's ingenuity and experience have led to the development of Pluto (PLUs Torque) screwdrivers, the most advanced DC tools in the market, able to reach 50 Nm. They feature an innovative coreless electric motor with low inertia and friction with absence of iron losses for extreme efficiency and extended life. Planetary gearboxes with high quality composite materials. Pistol grip to fit operator's hand ergonomically. PLUTO screwdrivers are available in pistol or inline styles; lever, trigger, or push-to-start. All models are ESD safe. Select models (Pluto 3, 5, 7 FR) also available in Clutch-Style torque adjustment.

Pluto CA/SR series drivers are designed for higher torque applications up to 50Nm. The CA/SR features a sleek design with a robust aluminium body allowing for operator comfort and durability. Torque & Angle models are also available.



PUSH-TO-START DRIVER

OPTIONAL RIGHT ANGLE HEADS-1/4" Hex; 3/8" sq. dr.

TUBE NUT & CROWS FOOT

PLUTO20CA/SR

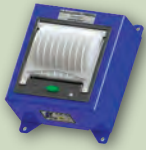
Model	Code	Torque Nm	RPM max	Weight Kg	Dimensions mm	Torque Adjustment	Style
PLUTO3D	130203	0,3-3,0	1200	0,55	216x40	Current	Inline
PLUTO3P	130204	0,3-3,0	1200	0,55	150x150x45	Current	Pistol
PLUTO3P/U	130205	0,3-3,0	1200	0,55	150x150x45	Current	Pistol/Cord Up
PLUTO3D/PS	130203/PS	0,3-3,0	1200	0,55	289x51	Current	Inline/Push-start
PLUTO3FR	131203	0,5-3,2	1300	0,55	273x40	Clutch	Inline
PLUTO5FR	131205	0,7-5,0	1000	0,55	273x40	Clutch	Inline
PLUTO6D	130206	0,5-6,0	920	0,55	216x40	Current	Inline
PLUTO6P	130207	0,5-6,0	920	0,55	150x150x45	Current	Pistol
PLUTO6P/U	130207/U	0,5-6,0	920	0,55	150x150x45	Current	Pistol/Cord Up
PLUTO6D/PS	130206/PS	0,5-6,0	920	0,55	289x51	Current	Inline/Push-start
PLUTO7FR	131207	1,0-7,0	600	0,55	273x40	Clutch	Inline
PLUTO10D/N	130211/N	1,5-10,0	600	0,55	216x40	Current	Inline
PLUTO10P/N	130210/N	1,5-10,0	600	0,55	150x150x45	Current	Pistol
PLUTO10P/U/N	130210/U/N	1,5-10,0	600	0,55	150x150x45	Current	Pistol/Cord Up
PLUTO10D/PS	130211/PS	1,5-10,0	600	0,55	289x51	Current	Inline/Push-start
PLUTO15D/N	130216/N	2,0-15,0	320	0,60	216x40	Current	Inline
PLUTO15P/N	130215/N	2,0-15,0	320	0,60	150x150x45	Current	Pistol
PLUTO15P/U/N	130215/U/N	2,0-15,0	320	0,60	150x150x45	Current	Pistol/Cord Up
PLUTO15D/PS	130216/PS	2,0-15,0	320	0,60	289x51	Current	Inline/Push-start
PLUTO20CA/SR	133221/SR	2,0-20,0	210	1,10	232,10x47	Current	Aluminium body, start/reverse buttons
PLUTO35CA/SR	133236/SR	2,0-35,0	140	1,50	246,60x57	Current	Aluminium body, start/reverse buttons
PLUTO50CA/SR	133250/SR	5,0-50,0	90	1,50	246,60x57	Current	Aluminium body, start/reverse buttons



PRNTR1 PRINTER



ETHERNET ASSIST

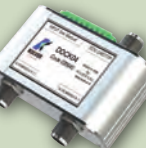

BAR CODE SCANNER

DOUBLE OUTPUT DEVICE
WITH CABLE
MODEL # DOCK-04

SWBX-88/TOP SWITCH BOX

CBS 880/TOP BIT/
SOCKET TRAY

EDU2AE



EDU2AE/HP



EDU2AE/HPro

PLUTO Control Units – Single & Multi-Torque

EDU2AE Series Controllers act as an AC to DC transformer and torque controller. The electronic control circuit cuts the power supply to the motor as soon as the pre-set torque has been reached. EDU2AE control units can be used in combination with any Kolver current control and/or clutch PLUTO screwdriver.

An easy-to-use scroll menu allows to select, set and/or adjust the following functions:

- Screwdriver model
- Tightening torque, fastening and unscrewing speed
- Type of joint (soft/hard)
- Acceleration ramp
- Min and Max fastening time
- Autoreverse

In addition to the above mentioned functions, EDU2AE/HP control unit features:

- Password protect settings
- Prevailing torque function (threadcutting)
- Clockwise or counterclockwise rotation (right or left screws) with torque control
- Torque value in Nm on the display through dedicated calibration menu
- Screw count function
- Min-Max torque interval with OK or NOK signal

The EDU2AE/TOP multiple torque system is designed to expand the functionality of the PLUTO screwdriver by enabling multiple torque settings (up to 8) using one controller and one driver.

Main features:

- One controller to handle torque from 0,2–50 Nm, depending on driver used.
- Easy to program user interface screens.
- 8 independent P-sets; with one PLUTO Driver you can replace up to 8 conventional screwdrivers.
- Each program can be adjusted: Torque, Speed, Hard/Soft Joint, Number of Screws to be tightened, Number of Rejects allowed, Minimum screwing time, Maximum screwing time, Ramp (slow start), Auto-reverse, Program sequence, Soft stop.
- Password protected.
- 15 input and 11 output connectors: all functions can also be controlled remotely.
- For retrieval of rundown data; USB and Serial Port comes standard.
- Optional Switch Box, Socket/Bit Tray, Bar Code Scanner, Printer and Ethernet assist are available.

EDU2AE/TOP/E has all of the features of the standard EDU2AE/TOP and the Expand software package for remote programming via USB port & PC.

All of the features of the EDU2AE/TOP/E come standard with EDU2AE/TOP/TA, the torque and angle control unit (see page 6).



EDU2AE/TOP



EDU2AE/TOP/E



EDU2AE/TOP/TA

Model	Code	Features	Dimensions mm	Weight Kg
EDU2AE	031000	Programmable with user interface screens	195x170x110	3,7
EDU2AE/HP	031000/HP	Programmable with interface screen, torque value and screw counting	195x170x110	3,7
EDU2AE/HPro	031000/HPRO	EDU2AE/HP with additional I/O and a serial port	195x170x110	3,7
EDU2AE/TOP	031000/TOP	8 P-set controller, parts counting, Torque display, 15 I/O, USB port	190x205x120	4,0
EDU2AE/TOP/E	031000/TOP/E	EDU2AE/TOP controller with Expand software for remote programming via USB port & PC	190x205x120	4,0

C A S E R I E S

CA Screwdrivers

The CA screwdrivers are designed for automated and fixtured applications. Special wiring and dedicated controllers are equipped with electric signals and contacts for immediate and easy interface. The ideal alternative to pneumatic drivers, they feature a long life maintenance free electric motor with a unique electronic torque control system for high accuracy throughout a wide torque range (up to 50 Nm); an aluminium body, for easy and quick clamp, supplied with 2,5 m cable.

The PLUTO..CA/FN2 Series incorporates the PLUTO DC-controlled electric screwdriver design, supplied in an inline aluminium housing for flange mounting applications. The DC motor and solid state controls of the PLUTO are ideal for automated high volume/high duty applications.

Flange and telescopic spindle available together or separately.



TELESCOPIC SPINDLE

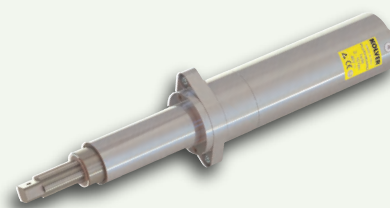

PLUTO..CA/FN2

*All CA are also available with torque and angle excluding the KBL series. Additional information available at www.kolver.it

Model	Code	Torque Nm	RPM max	L x Ø mm	Output	Control unit
NATO15CA	163015	1–15 Ncm	700	130x20	Half moon 4mm	EDU2AE/TOP/NT
MITO15CA	170016	0,2–1,5	850	226x36	Hex. 1/4"	EDU2AE Series
MITO15CA/FN	170016/FN	0,2–1,5	850	271,4x32,8	Hex. 1/4"	EDU2AE Series
PLUTO3CA	130303	0,3–3,0	1200	164x40	Hex. 1/4"	EDU2AE Series
PLUTO3CA/FN2	130303/FN2	0,3–3,0	1200	268,25x39,8	Sq. 3/8"	EDU2AE Series
PLUTO6CA	133206	0,5–6,0	920	164x40	Hex. 1/4"	EDU2AE Series
PLUTO6CA/FN2	133206/FN2	0,5–6,0	920	268,25x39,8	Sq. 3/8"	EDU2AE Series
PLUTO10CA/N	133211/N	1,5–10,0	600	164x40	Hex. 1/4"	EDU2AE Series
PLUTO10CA/FN2	133211/FN2	1,5–10,0	600	268,25x39,8	Sq. 3/8"	EDU2AE Series
PLUTO15CA/N	133216/N	2,0–15,0	320	164x40	Hex. 1/4"	EDU2AE Series
PLUTO15CA/FN2	133216/FN2	2,0–15,0	320	268,25x39,8	Sq. 3/8"	EDU2AE Series
PLUTO20CA	133221	2,0–20,0	210	232,10x47	Sq. 3/8"	EDU2AE Series
PLUTO20CA/FN	133221/FN	2,0–20,0	210	323,35x47	Sq. 3/8"	EDU2AE Series
PLUTO35CA	133236	2,0–35,0	140	246,60x57	Sq. 3/8"	EDU2AE Series
PLUTO35CA/FN	133236/FN	2,0–35,0	140	337,85x57	Sq. 3/8"	EDU2AE Series
PLUTO50CA	133250	5,0–50,0	90	246,60x57	Sq. 1/2"	EDU2AE Series
PLUTO50CA/FN	133250/FN	5,0–50,0	90	351x57	Sq. 1/2"	EDU2AE Series
KBL04FR/CA	190004/CA	0,04–0,4	1000	245,60x39,8	Hex. 1/4"	EDU1BL/SG
KBL04FR/CA/FN	190004/CA/FN	0,04–0,4	1000	330x39,80	Hex. 1/4"	EDU1BL/SG
KBL15FR/CA	190015/CA	0,4–1,5	1000	245,60x39,8	Hex. 1/4"	EDU1BL/SG
KBL15FR/CA/FN	190015/CA/FN	0,4–1,5	1000	330x39,80	Hex. 1/4"	EDU1BL/SG
KBL30FR/CA	190030/CA	0,7–3,0	1000	252,80x39,8	Hex. 1/4"	EDU1BL/SG
KBL30FR/CA/FN	190030/CA/FN	0,7–3,0	1000	338x40	Hex. 1/4"	EDU1BL/SG
KBL40CA	190040/CA	0,9–4,0	750	252,80x39,8	Hex. 1/4"	EDU1BL/SG
KBL40CA/FN	190040/CA/FN	0,9–4,0	750	338x40	Hex. 1/4"	EDU1BL/SG

CA Control Units



EDU2AE/HP



EDU2AE/TOP/TA



EDU2AE/TOP/E



EDU1BL/SG



MULTI SPINDLE

All Kolver Current Controlled screwdrivers work in combination with a control unit acting as an AC to DC transformer, and torque controller. Our exclusively designed circuitry monitors the power supply, and cuts power to the driver motor once the pre-set torque has been reached.

For the Pluto CA Series, the EDU 2AE Series controllers give the precise torque control for all automated operations at a fraction of the cost of transducer tools. Our unique design calculates the correct torque in response to three parameters; voltage, frequency, current draw.

Additional features:

- One controller only for a torque range from 0,2–50 Nm.
- Easy to program user interface screens.
- Soft or hard joint option.
- Slow start, adjustable RPM, Soft stop options.
- Autostop on elapsed time, automatic reverse options.
- Torque reached signal, and lever start signal.
- Remote start and Reverse start contacts.
- Internal calibration capability.

The EDU1BL/SG control unit is designed to work with our KBL Brushless drivers. These KBL drivers feature a maintenance free brushless motor, and the EDU controllers feature state-of-the-art electronics with zero wearing components.

Controllers come standard with:

- Slow start adjustment.
- RPM adjustment (60% to 100% of rated speed).
- Visual indicators (red-green) for power and torque.
- Input: Start and Reverse contacts.
- Output: 24 V DC for torque reached and lever signals.

Kolver also features Multi-Spindle units, including Pluto or Brushless controllers, CA spindles, all custom fixturing, and master PLC.

We invite you to contact us for further information.

Model	Code	Features	Dimensions mm	Weight Kg
EDU2AE	031000	Programmable with user interface screens	195x170x110	3,7
EDU2AE/HP	031000/HP	Programmable with interface screen, torque value and screw counting	195x170x110	3,7
EDU2AE/HPro	031000/HPRO	EDU2AE/HP with additional I/O and a serial port	195x170x110	3,7
EDU2AE/TOP	031000/TOP	8 P-set controller, parts counting, Torque display, 15 I/O, USB port	190x205x120	4,0
EDU2AE/TOP/E	031000/TOP/E	EDU2AE/TOP controller with Expand software for remote programming via USB port & PC	190x205x120	4,0
EDU1BL/SG	003000/SG	RPM and slow start adjustment, signals	138x118x37	0,6

ELECTRIC SCREWDRIVERS WITH T & A

Electric Screwdrivers – with Torque & Angle Control

Industrial tightening may require different control strategies and solutions. The most common cases are: torque control with angle monitoring and angle control with torque monitoring. Kolver Multi-Torque Torque & Angle controllers can manage all such strategies, with up to 8 individual P-sets.

The Torque/Angle Control

The main parameters to be controlled are the tightening torque applied to the screw and the rotation angle of the screw, with priority to the torque value. If the torque and angle values found by the system are within the programmed settings, the motor stops automatically and the indication of OK cycle (green led turned on) is given, otherwise an error (red led) is generated.

Features of the EDU2AE/TOP/TA:

The main parameters to be controlled is the rotation angle of the screw. The motor stops automatically when the pre-set angle value has been reached and an indication of OK cycle (green led turned on) is given.

Main features:

- New Expand software package for remote programming via USB port and PC.
- USB port on the front of the controller for uploading and downloading programs.
- Easy to program user interface screens.
- Password protected.
- Torque value in Nm, lbf.in and kgf.cm.
- Angle value in degrees.
- 8 independent programs including the options:
 - Min/Max torque value.
 - Min/Max angle value.
 - Rundown speed.
 - Slow start/Soft stop.
 - Hard/soft joint.
 - Min/Max rundown time.
 - Prevailing torque (threadcutting).
 - Auto reverse if required.
- 6 torque & angle strategies:
 - Torque priority: angle count from torque threshold (T) or from remote input (T/I) or from lever input (T/L).
 - Angle priority: driver stops when angle is reached from threshold torque (A) or from remote input (A/I) or from lever (A/L).

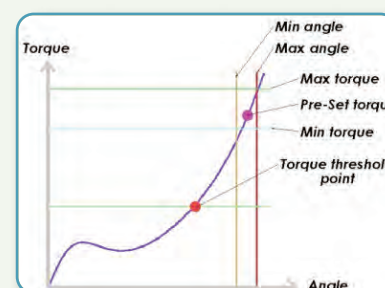
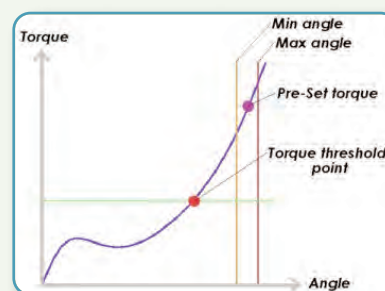

Model	Code	Torque Nm	RPM max	L x Ø mm	Output	Control unit
NATO15D/TA	160015/TA	1–15 Ncm	700	20x4,5	Hex. 1/4"	EDU2AE/TOP/TA
MITO15D/TA	170015/TA	0,2–1,5	850	226x36	Hex. 1/4"	EDU2AE/TOP/TA
PLUTO3D/TA	130203/TA	0,3–3,0	1200	216x40	Hex. 1/4"	EDU2AE/TOP/TA
PLUTO6D/TA	130206/TA	0,5–8,0	920	216x40	Hex. 1/4"	EDU2AE/TOP/TA
PLUTO10D/TA	130211/TA	1,5–10,0	600	216x40	Hex. 1/4"	EDU2AE/TOP/TA
PLUTO15D/TA	130216/TA	2,0–15,0	320	216x40	Hex. 1/4"	EDU2AE/TOP/TA
PLUTO20CA/SR/TA	133221/SR/TA	2,0–20,0	210	232,10x47	Sq. 3/8"	EDU2AE/TOP/TA
PLUTO35CA/SR/TA	133236/SR/TA	2,0–35,0	140	246,60x57	Sq. 3/8"	EDU2AE/TOP/TA
PLUTO50CA/SR/TA	133250/SR/TA	5,0–50,0	90	206,5x57	Sq. 1/2"	EDU2AE/TOP/TA



NEW FOR 2015: PLUTO SERIES WITH EXPAND SOFTWARE

PLUTO Control Units – TOP EXPAND

The EDU2AE/TOP/E and the improved version of our EDU2AE/TOP/TA are now available with programming software. Each control unit is supplied standard with EDU EXPAND software and an 8Gb USB flash drive. An external WiFi device is available on request.

Main features:

- PC programming (back panel): it is possible to set, change and save all parameters through our new "EDU EXPAND" software for PC. EDU EXPAND communicates with the control unit via mini-USB or RS232.
- Saving/programming on USB flash drive (front panel): you can now save the results of each screwing operation directly on USB pen drive!

It is also possible to upload via USB drive all parameters/programs previously set on "EDU EXPAND".

Just connect your USB to the port and recall the desired programs on the menu. The programs set on control unit can be downloaded on USB and recalled on another unit and on EDU EXPAND, too.

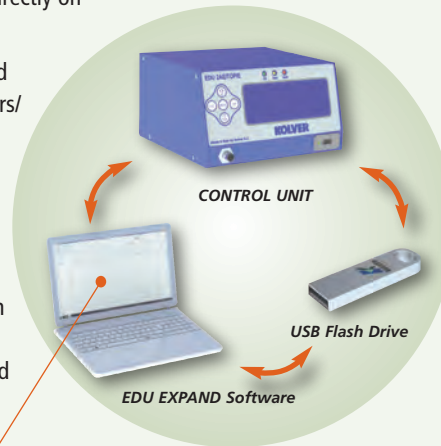

EDU2AE/TOP/E



EDU2AE/TOP/TA

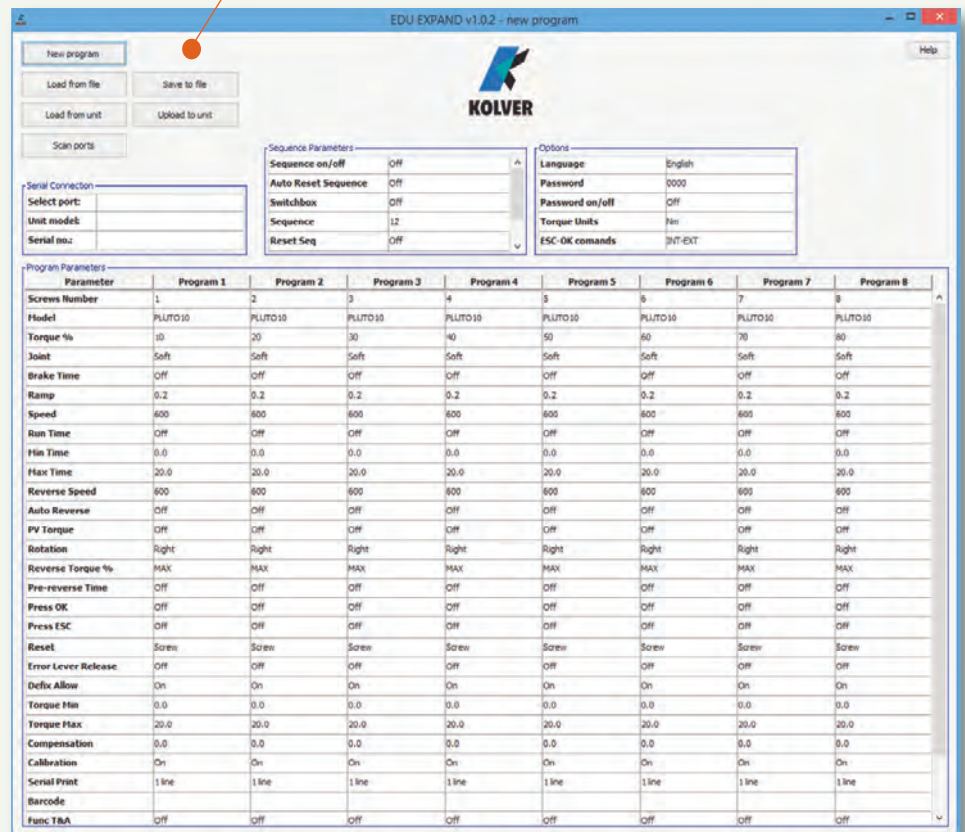

Model	Code	Features	Dimensions mm	Weight Kg	Screwdriver
EDU2AE/TOP/E	031000/TOP/E	EDU2AE/TOP controller with Expand software for remote programming via USB port & PC	190x205x120	4,0	PLUTO Series (see pages 2, 3 & 4)
EDU2AE/TOP/TA	031000/TOP/TA	8 P-set controller, parts counting, Torque display, 15 I/O, USB port	190x205x120	4,0	PLUTO/TA Series (see page 6)

F A B & R A F S E R I E S

FAB & RAF Screwdrivers

TORQUE UP TO 3,8 Nm

FAB series electric screwdrivers are our "best sellers" for the electronic industry. RAF series screwdrivers are designed to meet higher torque applications.

Their advanced ergonomic design, ease of use, high accuracy and durability have made these drivers the standard by which all others are measured. They are lightweight, compact, powerful and come standard with ESD-safe housing certified to SP method 2472 (Ericsson approved). These screwdrivers are available in an inline body style with either a lever start or push to start or in a pistol grip with a trigger start (also available with the cord coming out from the top - U option) and different speeds, for different assembly requirements.

The torque is set externally: an adjusting nut controls output torque by changing the clutch spring compression. A reference scale will indicate the torque setting. The low voltage 30 VDC rare earth motors combine high performances and long life. Replacing their carbon brushes once a year is all you need for maintenance.

The motor works in combination with a control unit. The electronic control circuit cuts the power supply to the motor in response to the clutch action, as soon as the pre-set torque has been reached. In addition the controller can be supplied with torque reached signal, lever signal, remote start and reverse (see page of control units for all the details) and with ACE screw counter unit.

All FAB and RAF drivers come standard with ESD-safe body, suspension bail and 2,5 m connection cable. Spiral cable available on request.

The new heavy duty cables and connectors, developed for robotic applications, are made of antistatic dissipative material for safe use in an EPA environment.



RIGHT ANGLE HEAD

Model	Code	Torque Nm	Screw size	RPM max	Start option	Weight Kg	L x Ø mm	Style
FAB03SS/FR	110003/FR	0,05–0,3	M2.5	650	Lever	0,48	226x36	Inline
FAB10RE/FR	110010/FR	0,05–0,8	M2.5	1000	Lever	0,48	226x36	Inline
FAB12RE/FR	110012/FR	0,2–1,2	M3	1000	Lever	0,48	226x36	Inline
FAB12PS/FR	112012/FR	0,2–1,2	M3	1000	Push start	0,48	226x36	Inline
FAB12PP/FR	110013/FR	0,2–1,2	M3	1000	Trigger	0,55	200x150x34	Pistol grip
FAB12PP/FR/U	110013/FR/U	0,2–1,2	M3	1000	Trigger	0,55	200x150x34	Pistol grip with top connector
FAB18RE/FR	110618/FR	0,3–1,8	M4	650	Lever	0,48	226x36	Inline
FAB18PS/FR	112618/FR	0,3–1,8	M4	650	Push start	0,48	226x36	Inline
FAB18PP/FR	110619/FR	0,3–1,8	M4	650	Trigger	0,55	200x150x34	Pistol grip
FAB18PP/FR/U	110619/FR/U	0,3–1,8	M4	650	Trigger	0,55	200x150x34	Pistol grip with top connector
RAF32NS/FR	120032/FR	0,7–3,2	M5	1000	Lever	0,65	247x40	Inline
RAF32PS/FR	122032/FR	0,7–3,2	M5	1000	Push start	0,65	247x40	Inline
RAF32PP/FR	120033/FR	0,7–3,2	M5	1000	Trigger	0,70	200x150x40	Pistol grip
RAF32PP/FR/U	120033/FR/U	0,7–3,2	M5	1000	Trigger	0,70	200x150x40	Pistol grip with top connector
RAF38NS/FR	120638/FR	0,9–3,8	M5	650	Lever	0,65	247x40	Inline
RAF38PS/FR	122638/FR	0,9–3,8	M5	650	Push start	0,65	247x40	Inline
RAF38PP/FR	120639/FR	0,9–3,8	M5	650	Trigger	0,70	200x150x40	Pistol grip
RAF38PP/FR/U	120639/FR/U	0,9–3,8	M5	650	Trigger	0,70	200x150x40	Pistol grip with top connector

FAB & RAF Control Units



All Kolver screwdrivers work in combination with a control unit acting as an AC to DC transformer and torque controller. The electronic control circuit cuts the power supply to the motor as soon as the pre-set torque has been reached.

The EDU1FR control units for FAB and RAF screwdrivers feature a maintenance free state-of-the-art electronics, with no wearing components with a circuit design suitable to both lever start and push start drivers with protection against current overload up to 10A. This design results in very low current to the driver's start switch and clutch switch to extend their life indefinitely. Additional features:

- Suitable to universal supply from 90 to 260 V ac 50/60 hz.
- Slow start (0-2 seconds) and RPM (60% to 100%).
- Visual indicators (green-red) for power on/off and clutch action.
- Reduced weight (0.6 kg) and compact size for easy placement.
- M12 waterproof connector with silver and gold contacts for perfect conductivity.

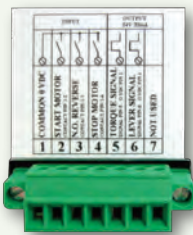

BACK CONNECTOR
EDU1FR/SG ONLY

The EDU1FR/SG controller features additional circuits wired to one connector in the back panel: output 24V for torque reached and lever signals; input start and reverse contacts. A double output connector (DOCK01) is also available for operators using two screwdrivers on the same working area (only FAB and RAF series). One end of this device is to be connected to the controller (cable included), the other end to the drivers. The screwdrivers are not to be used at the same time.



ACE SCREW COUNTER
MODEL # ACE 101/FR



DOUBLE OUTPUT DEVICE
WITH CABLE
MODEL # DOCK-01



SPIRAL CABLE



SOFT START AND SPEED
REGULATION

Model	Code	Features	Dimensions mm	Weight Kg	Screwdriver
EDU1FR	010010/FR	In: 90-260 Vca Out: 18-30 Vcc power 120VA slow start and adjustable speed	138x118x67	0,6	All FAB & RAF
EDU1FR/SG	010010/FR/SG	Input: start and reverse contacts Output: torque reached and lever signal	138x118x67	0,6	All FAB & RAF

BRUSHLESS Screwdrivers

TORQUE FROM 0,04 TO 4 NM

KBL series electric screwdrivers feature state-of-the-art brushless motors and clutch torque control, the perfect solution for clean room applications thanks to zero emissions of coal dust and other pollutants into the working environment. Small and lightweight for utmost operator comfort and with advanced ergonomic design, they ensure very low noise level, minimum vibrations and maximum safety (low supply voltage).

Magnetic clutch switches last 10 times more than traditional switches: the absence of maintenance operations guarantees high productive continuity. KBL screwdrivers are equipped with a sophisticated electronic torque control system that will cut the power supply to the motor as soon as the pre set torque has been reached. KBL drivers are available in inline body or for automation and they all come standard with an ESD-safe body. The new clutch for the adjustment of the tightening torque guarantees an excellent accuracy on the whole torque range. Rotation speed can be adjusted over a wide range: this function allows the operator to work on different materials always at the proper speed. They work with EDU1BL and EDU1FR control units (5 pin connector). KBL../S are equipped with innovative electronics, which processes and sends torque, error and lever signals and receives remote start and reverse input. They're mainly indicated for automated applications (KBL..CA, see dedicated page). They work with EDU1BL/SG control units (8 pin connector).

The new heavy duty cables and connectors, developed for robotic applications, are made of antistatic dissipative material for safe use in an EPA environment.



RIGHT ANGLE
HEAD

*All models available in pistol style

Model	Code	Torque Nm	RPM min-max	Weight Kg	L x Ø mm	Controller
KBL04FR	190004	0,04-0,4	650-1000	0,50	255x32	EDU1FR or EDU1BL
KBL15FR	190015	0,4-1,5	650-1000	0,50	255x32	EDU1FR or EDU1BL
KBL30FR	190030	0,7-3,0	650-1000	0,65	267x38	EDU1FR or EDU1BL
KBL40FR	190040	0,9-4,0	450-750	0,65	267x38	EDU1FR or EDU1BL
KBL04FR/S	190004/S	0,04-0,4	650-1000	0,50	255x32	EDU1BL/SG
KBL15FR/S	190015/S	0,4-1,5	650-1000	0,50	255x32	EDU1BL/SG
KBL30FR/S	190030/S	0,7-3,0	650-1000	0,65	267x38	EDU1BL/SG
KBL40FR/S	190040/S	0,9-4,0	450-750	0,65	267x38	EDU1BL/SG



EDU1FR



EDU1BL

EDU1BL/SG
Control Unit with Signals

BRUSHLESS Control Units

All Kolver screwdrivers work in combination with a control unit acting as an AC to DC transformer and torque controller. The electronic control circuit cuts the power supply to the motor as soon as the pre-set torque has been reached.

The EDU1BL, and EDU1BL/SG control units for KBL screwdrivers feature maintenance free state-of-the-art electronics with no wearing components.

They come standard with the torque knob to adjust the torque (from 60% to 100%) of current control tools and a green LED which indicates when the control unit is on. EDU1BL/SG control unit works with KBL..FR/S or KBL..FR/CA and it additionally features signals for reached/not reached torque, pressed lever and remote start/reverse.

A double output connector (Dock02) is also available for operators using two screwdrivers at the same time. KBL..FR screwdrivers work in combination with our standard EDU1FR controllers. This option will allow existing customers to replace FAB & RAF drivers with no need to replace controllers.

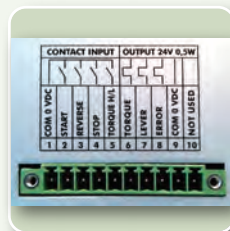
BACK CONNECTOR
EDU1BL/SG ONLY

ACE SCREW COUNTER

DOUBLE OUTPUT
CONNECTOR FOR KBL..FR

Model	Code	Features	Dimensions mm	Weight Kg	Screwdriver
EDU1BL	003000	Adjustable torque	138x118x37	0,6	KBL04FR, 15FR, 30FR & 40FR
EDU1BL/SG	003000/SG	Input: start and reverse contacts Output: reached torque and pressed lever	138x118x37	0,6	KBL04FR/S, 15FR/S, 30FR/S & 40FR/S

T L S 1 P O S I T I O N I N G A R M



TLS1

TLS1 Positioning Arm

The TLS1 Arm is an "intelligent" system that error-proofs your assembly ensuring that every screw is in the correct location at the right torque. Assembly sequences and X-Y coordinates are easily programmed with user interface screens through the keypad from the intuitive menu. Torque programs are automatically selected and enabled from the screwdriver controller based on the TLS1 Arm locations and current sequence step. No PC is required. A fixture to hold your work in the same place every time is highly recommended. The TLS1 Arm consists of a torque reaction arm with an encoder mounted at the pivot point and with a linear metering resistor. The encoder records the angle and the linear resistor records the distance. The TLS1 Control Box converts the angle counts of the encoder and the distance detected by the resistor to the precise X-Y position of the screwdriver. X-Y accuracy can be set by the operator according to each application.

TLS1 arm includes cable for EDU1FR/SG (code 260003) or EDU2AE and EDU1BL/SG (code 260004) controllers.

Main features:

- 8 available programs.
- Up to 35 screws per program.
- Screw position (length/angle).
- Programmable tolerance.
- Statistics.
- Manual reset.
- Password protected.
- Units of measurement (mm, in).
- Language option.
- Accuracy: length ± 1 mm.
angle $\pm 1^\circ$.
- External keyboard and serial port for easy programming and reporting.



TLS1 BOX

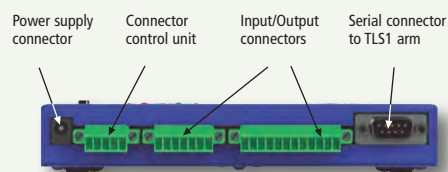

Model	Code	Min Reach mm	Max Reach mm	Max Torque Nm
TLS1/CAR281	010663/TLS1	550	1000	25
TLS1/CAR282	010664/TLS1	800	1720	25
TLS1/CAR501	010665/TLS1	550	1000	50
TLS1/CAR502	010666/TLS1	800	1720	50

Do You Need Error Proofing?

You can upgrade Folding arms, most Rail arms, or create a custom arm with Smart-Control. Smart-Control consists of up to three (3) encoders at the pivot locations of the Smart arm, linked to a control system that converts the data from the encoders to an X & Y location.

What Is Smart-Control?

Smart-Control upgrade adds positional tracking to your torque arm, based on user-defined locations. Smart-Control knows the X & Y location of your screwdriver. When correct location is reached, the pre-defined torque program (P-set) is automatically selected, and power is activated to the screwdriver.

Smart-Control Features:

- Program 5 separate jobs with forty (40) locations each.
- Add a Bit/Socket tray to confirm the correct applicator is being used.
- Add Smart-Bins to confirm the correct fastener is being used.

*We invite you to contact us for further information

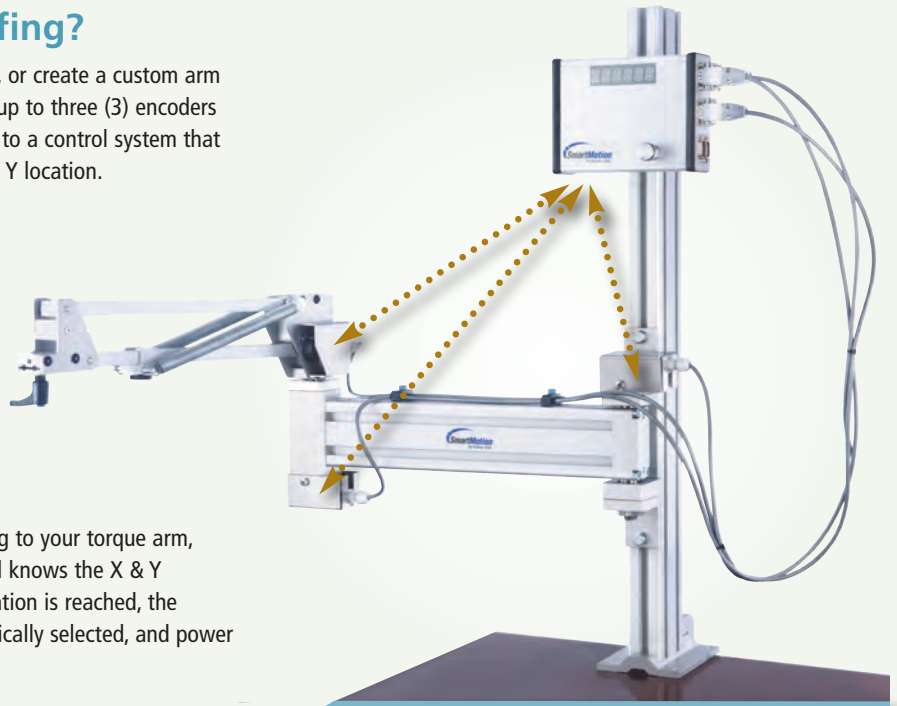

SMART BIN

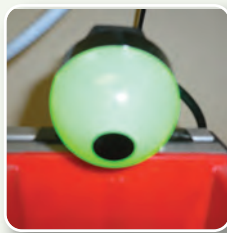

BIN SENSOR



BIT TRAY

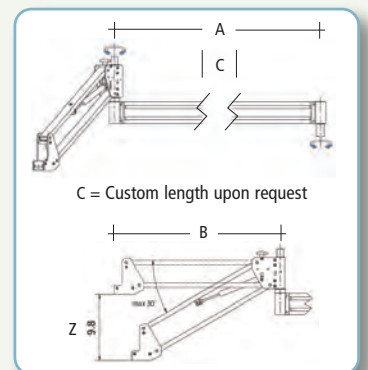

TORQUE TESTER - K Series

The K Series is a totally new class of analyzers. They feature a built-in transducer and also have the unique ability to connect to an external transducer. Using a high performance circuitry they collect, store and eventually download torque measures for a complete analysis of the tool and/or the joint. Priced at a low level, this tester has become popular among those companies wishing to improve their product quality through the precise control of torque.



- User friendly menu.
- Accuracy: +/- 0.5% of the displayed value.
- Internal transducer for tests on a joint simulator (supplied with the unit).
- Connection for external transducer (transducer not included).
- 500 readings memory.
 - Selection among Nm, Ncm, Kg.cm, in/lbs.
 - RS232C output (cable not included).
 - Indication <=> of the preset values.
 - Output signal at preset reached value.
- Clockwise and counter-clockwise measurement.
- 3 models of operation: Peak +, Peak -, Track.
 - Manual or automatic reset.
- 9 V rechargeable battery provide 4 hours of continuous operation. Automatic switch off to reduce battery consumption.
- 125% transducer overload protection.
- English and Italian menu.

Supplied in a plastic carrying case, with one rechargeable battery, 1 joint simulator (semielastic), instructions manual and certificate of calibration. Additional joint simulators (rundown adapters) for hard joint or fully elastic joint available on request.

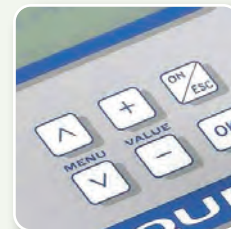

JOINT SIMULATOR

EXTERNAL ROTARY
TRANSDUCERCONNECTING
PORTS

KEYPAD

Model	Code	Torque Nm	Dimensions mm	Weight Kg
K1	020402	0,05–1	180x105x55	1,0
K5	020403	0,3–5	180x105x55	1,0
K20	020404	0,5–20	180x105x55	1,0
KTE5	022405	0,5–5	External rotary transducer for K5	
KTE25	022425	2–25	External rotary transducer for K20	

TORQUE TESTER - MINI SERIES



Controlling torque is vital for companies to ensure their product's quality. Fasteners that are insufficiently torqued can vibrate loose and excessive torque can strip threaded fasteners. Using a quality torque analyzer has become increasingly important for many companies to ensure that proper torque is being applied.

TORQUE TESTER - Mini K Series

MINI K Torque Analyzers feature a built-in transducer. The easy-to-use torque tester is ideal for checking all power tools up to 20 Nm. The small size and portability of the MINI K makes it ideal for checking torque tools on the production floor regularly to ensure the tools are always calibrated.

- Built-in transducer.
- Three models with 1 Nm, 5 Nm and 20 Nm max torque.
- Three units of torque measurement available; Nm, Kg.cm, in/lbs.
- Four digit display.
- Manual and auto reset functions to clear displayed values.
- Battery powered (9V) and AC adapter. 9V battery provides 30 hours of continuous operation.
- RS232C serial port as option with date and hour
- Automatic shut down to extend battery life.
- Torque Tester includes a spring washers joint simulator (miniK25 and miniK20) or built in joint simulator (miniK1) and a case.

Accuracy: 0.5% of reading from 10% to 100%.

Accuracy: 1% of reading from 1% to 10%.

Model	Code	Torque Nm	Dimensions mm	Weight Kg
mini K1	021402	0,03–1	150x70x45	0,80
mini K5	021403	0,1–5	150x70x45	0,80
mini K20	021404	0,5–20	150x70x45	0,80



TORQUE TESTER - Mini Ke series

The Mini Ke system consists of a torque readout and an external rotary transducer. The Rotary Torque Transducer is the ideal torque-auditing tool for testing the actual torque being applied on the assembly application. By connecting a rotary torque transducer between an electric or pneumatic tool and an assembly application, you can monitor the real torque being applied from the tool to fastener or bolt.

Accuracy: 0.5% of reading from 10% to 100%.

Accuracy: 1% of reading from 1% to 10%.

Correction factor (FATC): it is possible to connect different transducers to the same torque reader.

Model	Code	Torque Nm	Tester Dimensions mm	Rotary Transducer Dimensions mm	Weight Kg
mini Ke 5	021405/5	0,5–5	150x70x45	25x92	0,50 (without transducer)
mini Ke 25	021405/25	2–25	150x70x45	25x92	0,50 (without transducer)
mini Ke 50	021405/50	Up to 50	150x70x45	89,5x52x63,5	0,50 (without transducer)
mini Ke	021405	Transducers up to 500 Nm available upon request	150x70x45		0,50 (without transducer)

N - G I N E R I C T R A N S D U C E R S



ROTARY Transducers

Rotary Transducer featuring USB connection to PC, Tablet or Android phone "no separate analyzer required". Sensor includes high precision strain gauge, encoder and brushless signal transmission, with clutch overload protection up to 2Nm. Interface can be either USB only or Intelligent with Ethernet and RS-485 connection.

Note: Models up to 500Nm available.

n-quirer software:

Automatically identifies which n-gineric sensor is connected and displays graphs of Torque vs. time, angle and/or Force displacement. Live graphs can be overlaid onto a reference graph for process analysis. All data is collected and exported directly to an Excel template for automatic generation of your calibration certificates with SPC data included.

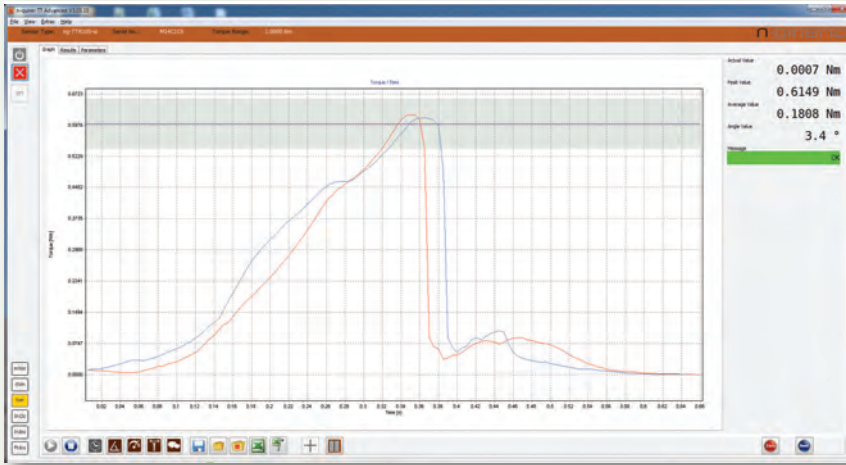

n·gineric



STATIONARY Transducers

Stationary Transducer featuring direct connection to PC, Tablet or Android phone "no separate analyzer required". Sensor includes high precision strain gauge with brushless signal transmission and clutch overload protection up to 2Nm. Interface can be either USB only or Intelligent with Ethernet and RS-485 connection.

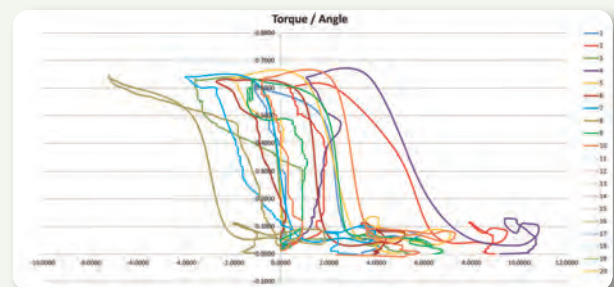
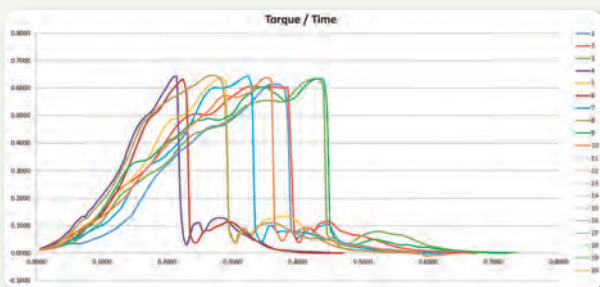



ACE Screw Counter

The ACE screw counter is a process control system that monitors the fastening assembly process. It tracks, in real time, the fastening of each screw in an assembly, then notifies the result. It keeps a summary of good and complete assemblies as well as of bad and incomplete ones throughout the production day. The ACE is easily programmed with user interface screens through the keypad. Walk through a few simple steps to input the parameters for total number of fasteners required in a completed assembly and the fastening process can begin. The unit gives the operator audible and visual indications that the assembly has been completed without error and it is safe to move on to the next process step or if it has been rejected.

Main features:

- ACE includes the screw counter + cable for connection to the control unit.
- To be connected to EDU2AE (code 020022), or EDU1FR/SG (code 020021).
- 8 independent programs.
- Up to 99 screws for each program.
- Sequence of 4 programs.
- Min and max fastening time (accuracy: 0.01 sec).
- Separate displays for parameters setting and fasteners count.
- OK, End Cycle and Error lights.
- Statistics: Total number of correct screws done, wrong screws, cycles done, sequences done.
- I/O signals.
- Password protected.
- Wall mountable.
- Remote control of the system (optional).
- RS232 port.

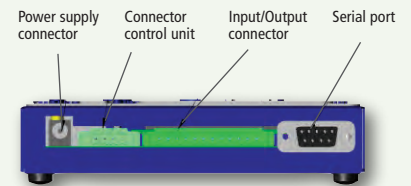
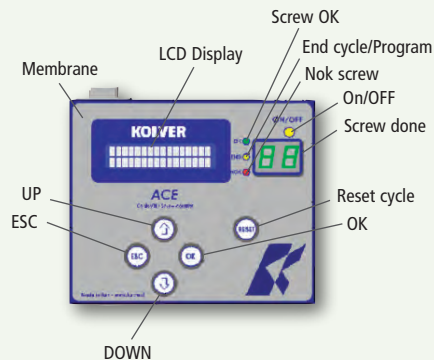

Model	Code	Dimensions mm	Weight Kg	Controller
ACE	020021	137x133,4x30,20	0,55	EDU1FR/SG
ACE	020022	137x133,4x30,20	0,55	EDU2AE

A C C S E R I E S

ACC Screwdrivers

ACC screwdrivers with shut off torque control through mechanical clutch are direct plug-in tools with built-in PCB for automatic cut off and AC to DC rectifier. They are ideal for applications where portability is needed to minimize costly set-up time. ACC models have the unique feature of selectable push to start or push and lever start. To select the working mode just slide the switch located by the start lever.



3 POSITIONS
REVERSE SWITCH



TORQUE ADJUSTING
NUT COVER

Model	Code	Torque Nm	RPM Max	Weight Kg	L x Ø mm	Controller
ACC2210	141910	0,2–1,0	950	0,75	255x35	230 Vca
ACC2220	141920	0,7–2,0	950	0,80	255x35	230 Vca
ACC2222	151222	0,9–2,0	2400	0,85	265x38	230 Vca
ACC2230	151930	1,0–3,0	950	0,85	265x38	230 Vca
ACC2245	151945	1,0–4,5	950	0,85	265x38	230 Vca

Optional Lock-out Cover & Nut Assembly available for all ACC models (code 219011).

S C R E W F E E D E R S N F K S E R I E S



The new Kolver feeders, model NFK-Nxx (xx stands for the screw size) are supplied with interchangeable spacers between the rails (spacer size: 1.3mm to 5.3mm). You can also combine spacers to reach the desired rail width. Dimensional drawings and complete up-to-date info available on our website. The new NFK UNI can be used with any (non-countersunk) screw with diameter 1,4–5,0mm.

Model	Code	Max Shank Ø mm	Screw Length Min/Max mm
NFK N14	014514	1,4	1,4/20
NFK N17	014517	1,7	1,7/20
NFK N20	014520	2,0	2,0/20
NFK N23	014523	2,3	2,3/20
NFK N26	014526	2,6	2,6/20
NFK N30	014530	3,0	3,0/20
NFK N40	014540	4,0	4,0/20
NFK N50	014550	5,0	5,0/20
NFK UNI	014705	1,4–5,0	20

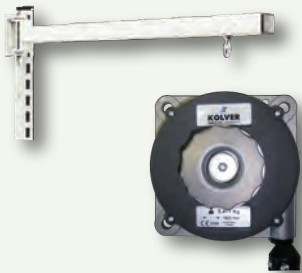

Light Tower Stack

The light stack allows better visibility of output signals. Made for any control unit with signals. Supplied standard with 2,5m cable and 10pin connector for CN1 (EDU2AE - EDU2AE/TOP). Wiring for other Kolver control units available upon request.



Pivoting Arm and Tool Balancer

ARMPV1 support arms, code 010500, consist of a vertical support on which a 180° pivoting arm is attached. Tool balancers TECBA1, code 010300, allow screwdrivers to be positioned over the work station for comfortable operation. Models with capacity up to 180 kg available upon request.



Suction Head and Autocatcher

The Suction Head is the best way to handle non-magnetic screws (stainless steel, brass, plastic etc). It is designed to be used with any screwdriver! Model A2 (code 010111/1) for M2-M2,6 screws and A3 (code 010111/2) for M3-M4 screws. Vacuum generator and vacuum pump supplied upon request.

As an alternative the Autocatcher allows you to pick up and fasten the screws by one hand, thanks to its plastic clamp.

R E A C T I O N A R M S

Linear Arm

The Linear arm (code 010681) maneuvers smoothly as it absorbs the torque reactions from the screwdrivers providing ergonomic support for the operator. The fluid movement increases precision and production for a variety of torque applications. Prevents cross threading and side load. Keeps tool perpendicular. Reduces RMI (Repetitive Motion Injury) and CTS (Carpal Tunnel Syndrome) while boosting production. Extends in horizontal direction and arm length is adjustable.



Model	Code	Max Torque Nm	Max Reach mm	Min Reach mm
LINAR1	010681	25	665	184

T E L E S C O P I C T O R Q U E R E A C T I O N A R M S

Telescopic Arm Series

CAR series torque reaction arms are designed to eliminate the reaction that screwdrivers generate when they stop at the preset torque (up to 50 Nm). Their carbon structure makes them extremely lightweight and incredibly resistant at the same time. For such reasons they resist degradation in high fatigue applications much better than conventional materials.



Model	Code	Min reach mm	Max Reach mm	Weight Kg	Max Torque Nm
CAR101	010661	549	906	0,25	10
CAR281	010663	490	950	0,60	25
CAR282	010664	730	1650	0,75	25
CAR501	010665	490	950	0,65	50
CAR502	010666	730	1650	0,80	50

Suspended Torque Arm Series

The new Suspended Torque Arms are the ideal solution to increase productivity. They can be easily installed on most workplaces to help the operator handle the screwdriver in total safety and stability:

- With minimized reaction force you will also improve finished product quality because there is no movement of the tool and all torque is absorbed in the joint.
- Improve the comfort of the operator and the productivity clearing the work area.

Three models available, depending on the motion of the axes:

- SAR15 Z -> Z Axis
- SAR15 XZ 85 -> XZ Axes
- SAR15 XYZ 855 -> XYZ Axes

The new arms are supplied without tool holder - to be purchased depending on the screwdriver:

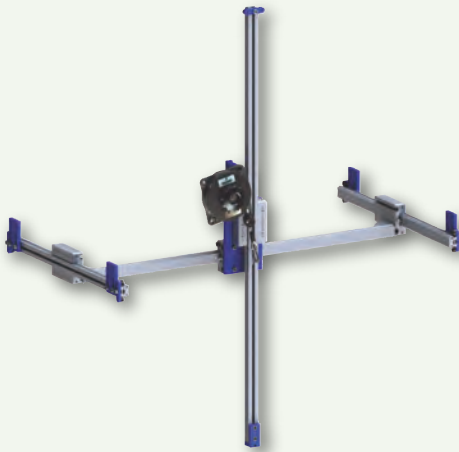

TOOL HOLDER FOR PLUTO
INLINE



TOOL HOLDER FOR PLUTO
WITH ANGLE HEAD



UNIVERSAL TOOL HOLDER
FOR ANY SCREWDRIVER

Model	Code	Vertical Stroke "Z" mm	Horizontal Stroke "X" mm	Lateral Stroke "Y" mm	Max Torque Nm
SAR15 Z	010690/Z/5	364	/	/	15
SAR15 XZ 85	010690/XZ/85	364	692	/	15
SAR15 XYZ 855	010690/XYZ/855	885	692	376	15
Tool holder for PLUTO inline	010695	For any PLUTO..D, PLUTO..FR, PLUTO..D/TA e RAF..NS/FR			
Tool holder for PLUTO w/angle head	010695/P	For any PLUTO..ANG			
Universal Tool Holder	010695/UNI	For any screwdriver (max diameter 47mm)			



OUR COMPANY

Founded in 1989, KOLVER has soon taken the leadership in the European market of precision electric screwdrivers for industry. Thousands of state-of-the-art drivers are produced every year in Italy and then shipped to more than 30 countries worldwide.

ISO 9001 certified since 1998, KOLVER has gained international recognition for building premier quality innovative products that meet or even anticipate the most rigorous customer requirements.

The Kolver family of tools is one of the most comprehensive in the electric power tool industry covering a wide range of torque at several speeds, suitable for an indefinite number of applications. Kolver tools feature either shut off clutch or current control system, coreless or brushless motors all controlled by a state-of-the-art electronic control unit. Thanks to their low installation, operating and maintenance costs as well as to their reduced vibration and noise level, Kolver electric screwdrivers represent the perfect alternative to pneumatic screwdrivers for screws up to M10.



ONE YEAR LIMITED WARRANTY

This KOLVER product is guaranteed against defective workmanship or materials, for a maximum period of 12 months following the date of purchase from KOLVER, provided that its usage is limited to single shift operation throughout that period. If the usage rate exceeds that of single shift operation, the guarantee period shall be reduced on a prorata basis.

If, during the guarantee period, the product appears to be defective in workmanship or materials, it should be returned to KOLVER or its distributors, transport prepaid, together with a short description of the alleged defect. KOLVER shall, at its sole discretion, arrange to repair or replace free of charge such items.

This guarantee does not cover repair or replacement required as a consequence of products which have been abused, misused or modified, or which have been repaired using not original KOLVER spare parts or by not authorized service personnel.

KOLVER accepts no claim for labour or other expenditure made upon defective products. Any direct, incidental or consequential damages whatsoever arising from any defect are expressly excluded.

This guarantee replaces all other guarantees, or conditions, expressed or implied, regarding the quality, the marketability or the fitness for any particular purpose. No one, whether an agent, servant or employee of KOLVER, is authorized to add to or modify the terms of this limited guarantee in any way. However it's possible to extend the warranty with an extra cost. Further information at kolver@kolver.it.

KOLVER SCREWDRIVER IS...

- **ERGONOMIC**
Advanced grip design, light in weight, vibrations within the norms, for maximum operator comfort
- **CLEAN**
No air exhaust + No lubrication = a cleaner environment
- **SAFE**
The tool works below 50 V
- **FLEXIBLE**
From the controller you can adjust the running speed and the slow start duration.
Multi torque models also available for additional functions
- **ACCURATE**
With the electronic shut off mechanism the accuracy is better than $\pm 5\%$ of the pre-set value
- **FOR EVERY APPLICATION**
Range up to 50 Nm, straight, pistol, 90°, ESD, with vacuum, lever start or push to start...
- **NOISELESS**
Noise within 55 dB(A)
- **COST EFFECTIVE**
Low purchasing price + virtually no maintenance + no need of compressed air line + no need of spiral hoses & couplers & filters & regulators-lubricators = operating cost up to 200 times cheaper than pneumatic screwdrivers